

# Roca

## SITE

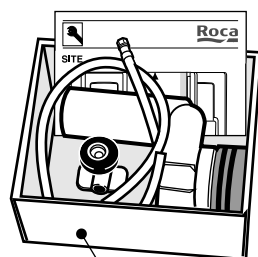

**8-92014000**

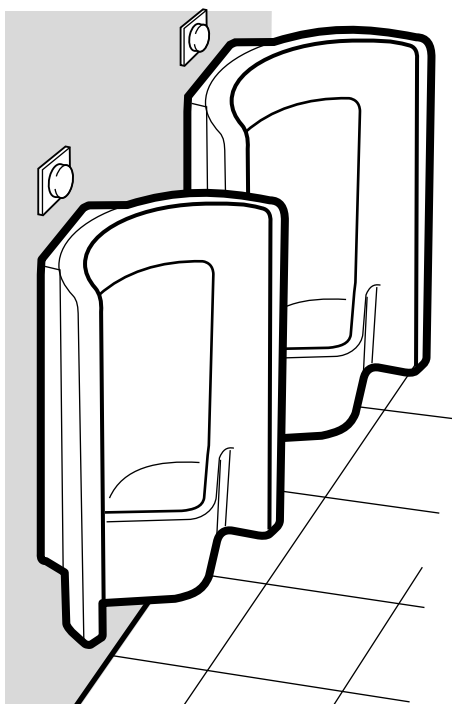
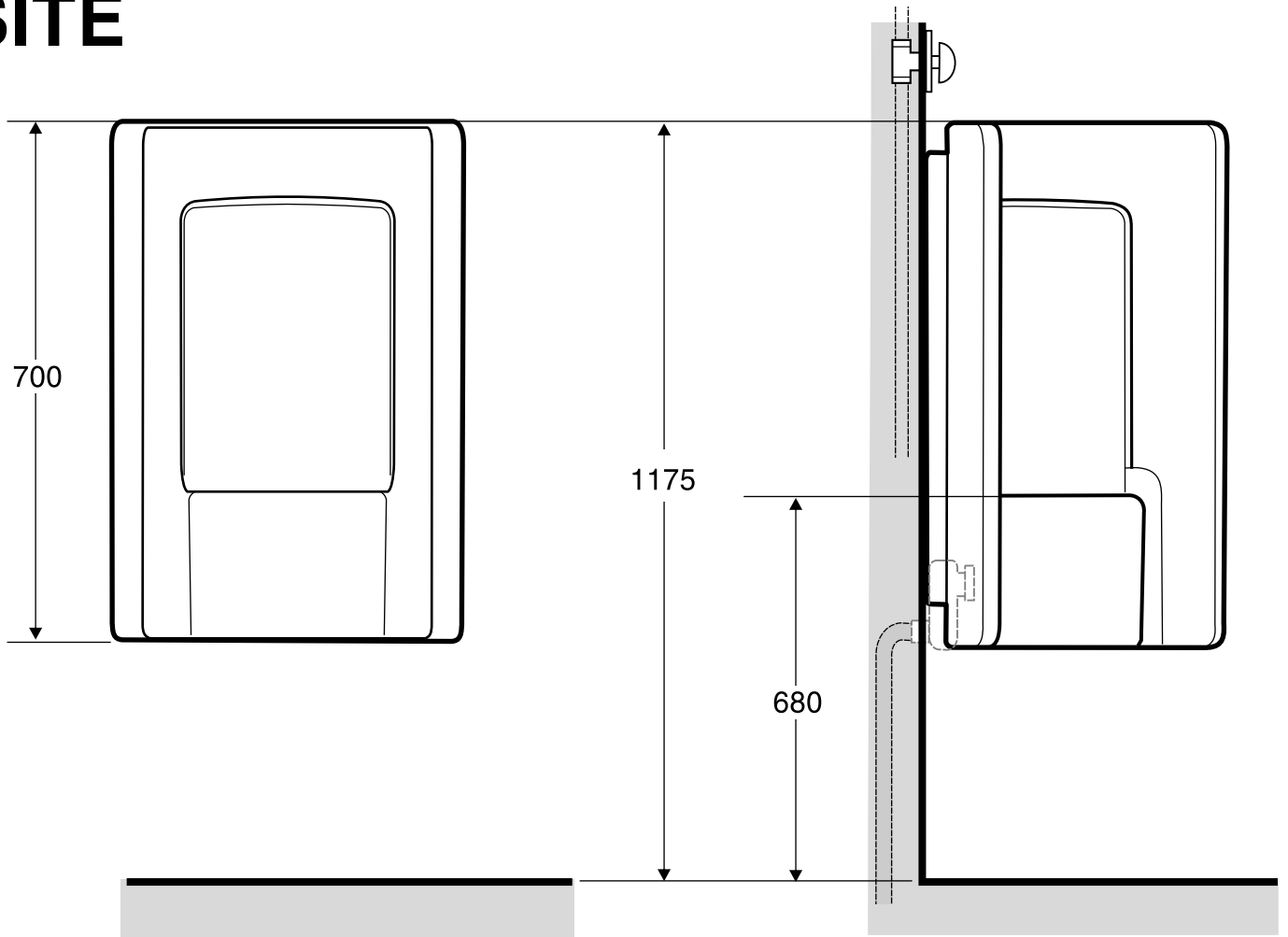
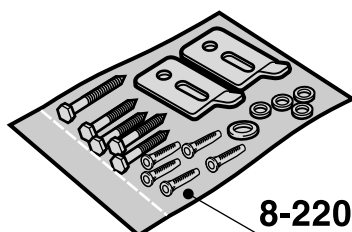

**8-22057300**

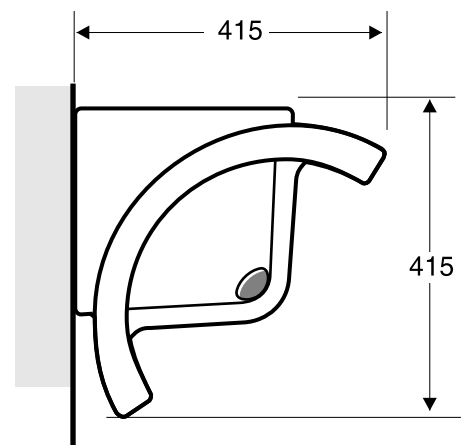

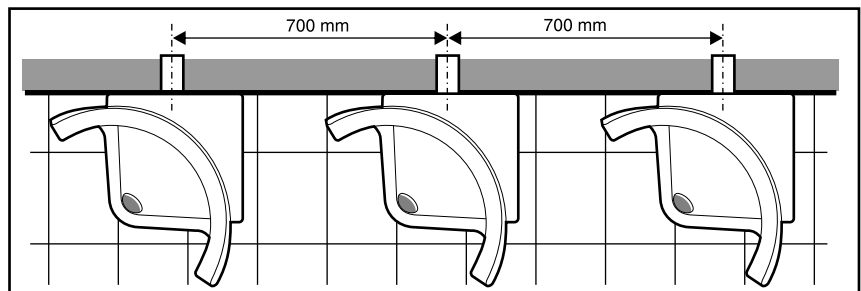
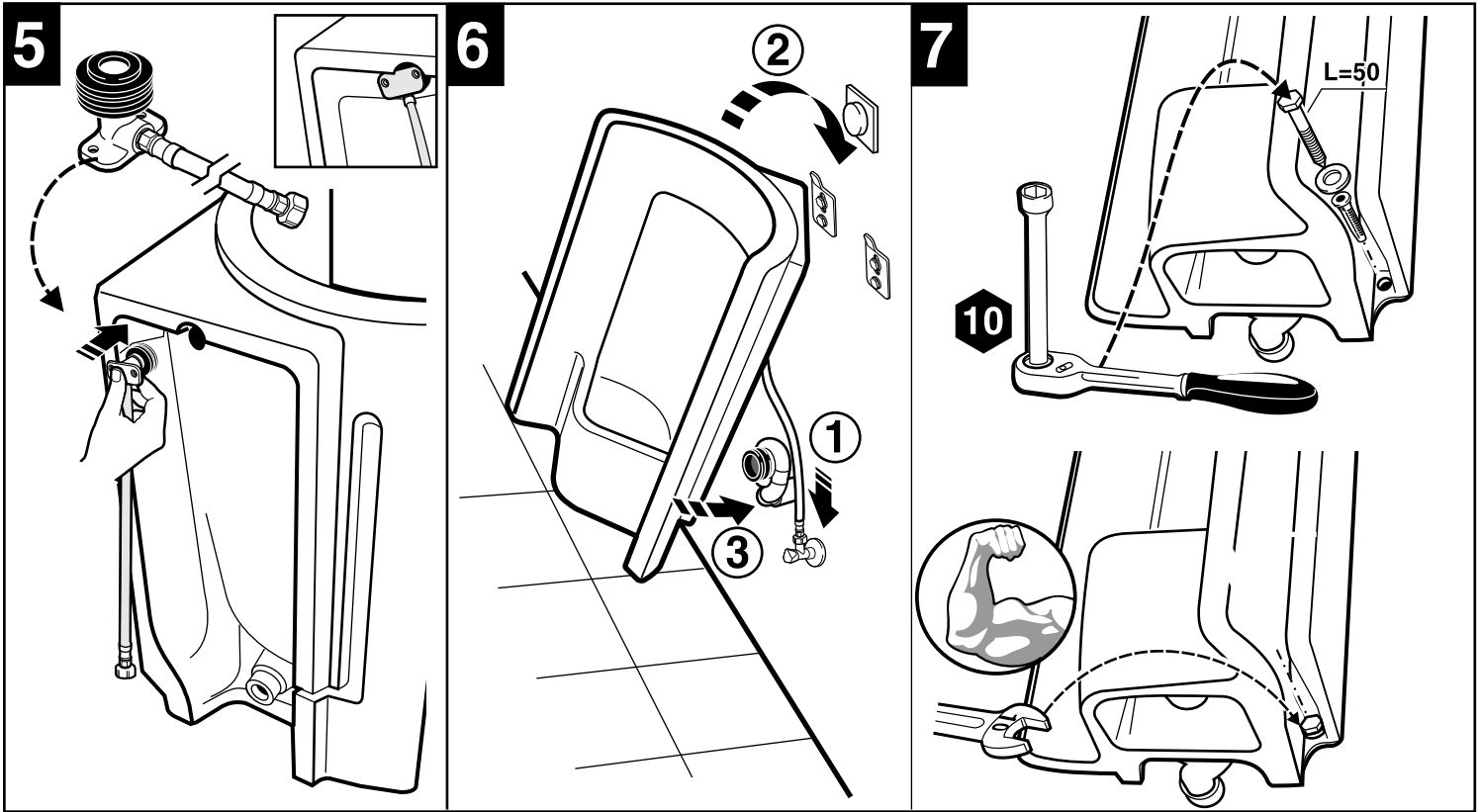
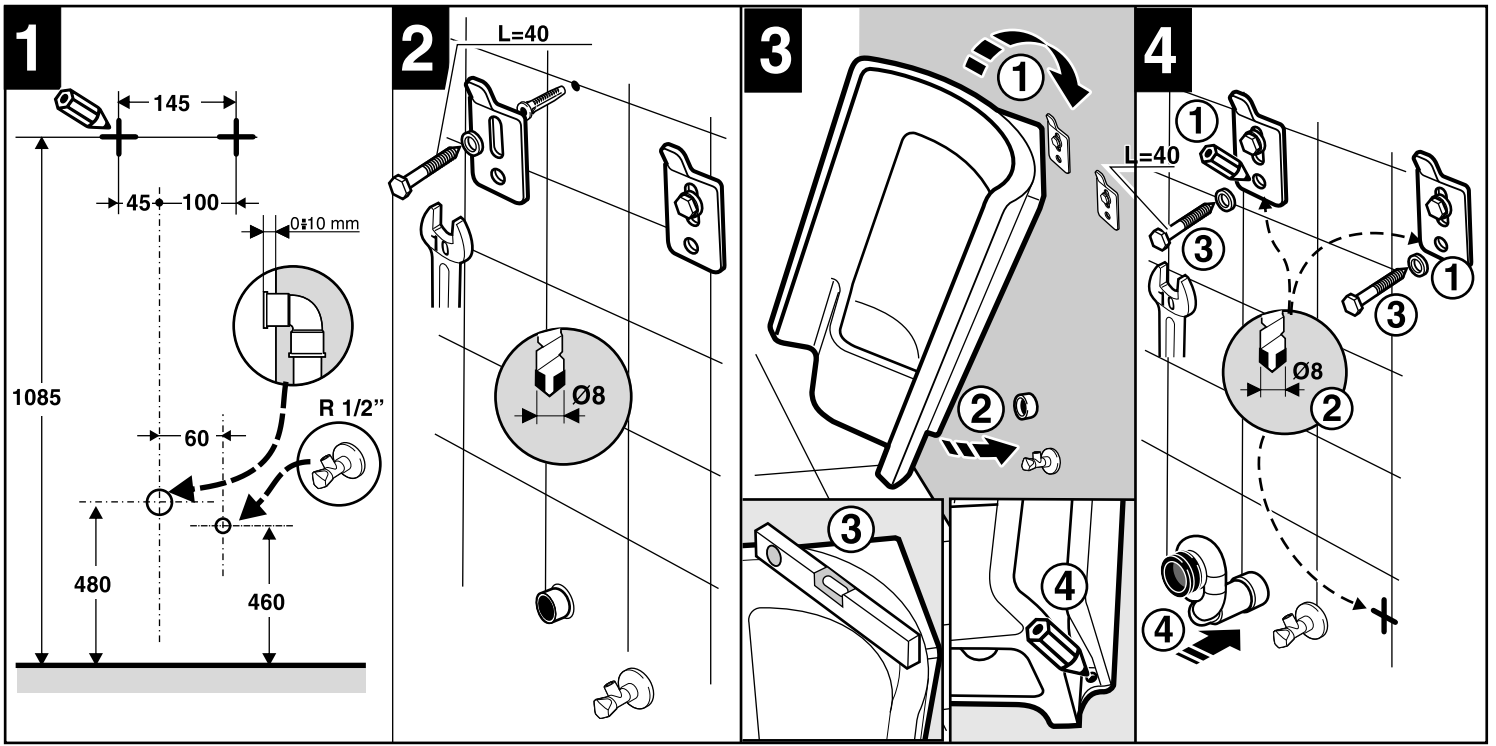

Roca Sanitario, S.A.

Avda. Diagonal, 513  
 08029 Barcelona - SPAIN  
 Teléfono 93 366 1200  
 Fax 93 419 4501  
 www.roca.es

**Roca**